



This guide will cover the basics for the ACCUWAVE Series. (ACCUWAVE Plus / ACCUWAVE Pro / ACCUWAVE Premier)

### 1. Unpacking

Unpack your monitor and plug in all sensors and cables. All the cables are keyed so they will only plug in where they are supposed to go. You may plug and unplug your sensor cables at any time whether the power is on or off.

Connector Position  
ACCUWAVE series

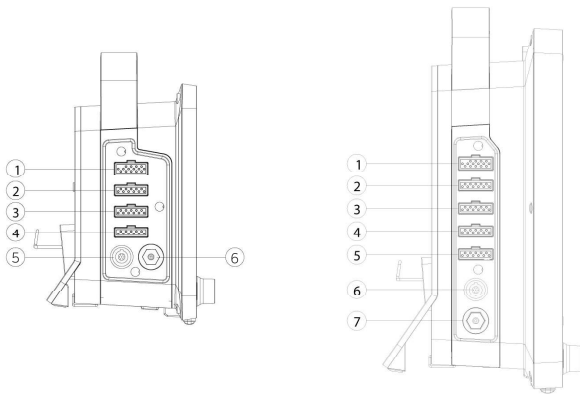

- ① ECG connector
- ② SpO2 connector
- ③ Temperature connector
- ④ IBP connector 1
- ⑤ EtCO2 / Dual Gas Module connector
- ⑥ NIBP tube connector

- ① ECG connector
- ② SpO2 connector
- ③ Temperature connector
- ④ IBP connector 1
- ⑤ IBP connector 2
- ⑥ EtCO2 / Dual Gas Module connector
- ⑦ NIBP tube connector

### 2. Menu Selection

Turn your monitor on. Touch the screen or turn the rotary knob to move the cursor around the screen and press the center of it to select the highlighted item.

Control Keys/Knob Position  
ACCUWAVE series



\* Image shown is ACCUWAVE Premier

- ① Alarm lamp
- ② Power ON/OFF key
- ③ Alarm control key
- ④ Snapshot key
- ⑤ NIBP measurement key
- ⑥ Rotary knob

### 3. Printer Module

Connect the printer cable from the printer module to the printer connector port located on the backside of the monitor. The printer can be mounted on the side.



Front

Back



Printer Module Mounting

\* Image shown is ACCUWAVE Premier

### 4. Electrocardiogram (ECG)

#### 4.1. 3-Lead Alligator Clip

You will have both a 3-lead alligator clip and an esophageal ECG/Temperature probe. Either one can be plugged into your ECG extension cable.

\*Image shown is for reference purposes only

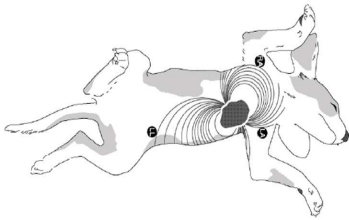

Position of 3-Lead Wire Electrodes



ECG 3-Lead Alligator Clip



ECG 3-Lead Extension Cable for ACCUWAVE series



To ECG Jack of ACCUWAVE series



#### 4.2. Esophageal ECG Probe

The ECG esophageal probe will provide you with both a 3-lead ECG and temperature.

**IMPORTANT: The default respiration (labeled as "rpm" in yellow on the display) is dependent on the placement of the electrodes or the alligator clips. If you use the esophageal probe, then you must monitor respiration using alternative means, such as the End-Tidal CO2 option.**

Before inserting the esophageal probe into your patient's esophagus, measure it against the patient to ensure that you do not insert it further than the base of the sternum. Then, while slowly inserting the probe into the esophagus, observe the ECG tracing. When you obtain a good QRS signal, stop and secure the esophageal probe in place to minimize movement. If you observe an inverted R-wave, it means you have inserted the probe too far, and you must withdraw it until the QRS is normal.

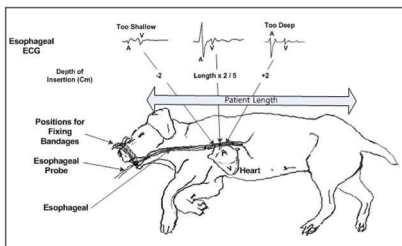

**Electrode diameter:**

- 8 mm (for small, medium)
- 6 mm (for extra small)

**Electrode length:**

- 70 mm (for medium)
- 45 mm (for small, extra small)
- 800 mm (for medium)
- 500 mm (for small, extra small)



To patient's esophagus

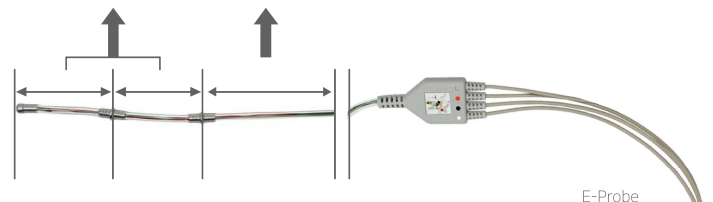

E-Probe



To ECG Jack of ACCUWAVE series



To Temperature Jack of ACCUWAVE series

ECG 3-Lead Extension Cable for ACCUWAVE series

Temperature Extension Cable for ACCUWAVE series

### 5. SpO2

#### 5.1. Y-Clip Sensor

The ACCUWAVE series comes standard with two SpO2 sensors. One is the classic Y-Clip sensor, commonly called a lingual clip. This can be used on the lip, tongue, vulva, prepuce, webbing between the toes and the webbing behind the tendon on the hind leg.



Y-Clip Sensor



SpO2 Extension Cable

#### 5.2. Transflectance Probe

The other is the Transflectance probe. This is often mistaken as a rectal probe, though it can be used rectally; we do not recommend rectal pulse oximetry. To be successful, you would need to perform pre-surgical enemas on your patients. This probe works best when taped to the underside of the base of the tail. In some cases, you may have to shave some fur. You may also use this probe on the inside of the thigh, the midline of the belly, and the back of the leg just above the pads of the feet.



Transflectance Probe



SpO2 Extension Cable

**Note:** The probe simply plugs into the SpO2 extension cable.

### 6. NIBP

The most important factors in achieving a successful and accurate blood pressure measurement are proper cuff size selection and placement.

The cuffs are all graduated, allowing you to easily identify the correct-sized cuff to use. There is an index point marked on the leading edge of the cuff. When taped to the limb, this index point must be within the graduated scale.



Child cuff showing Index Line and Graduated Scale.



Cuff is too small.  
Index edge won't fall within scale.



**Cuff is correct size.**



Cuff is too large.  
Index line won't fall within scale.

\* The child cuff is example image and is not included as a standard or optional component.

The hose should align with the vessel that you are trying to measure. When using a leg, this is on the underside (backside) of the leg.



**Incorrect**



**Correct**

*Note: While measuring the blood pressure, the cuff must be at the same level as the patient's heart for best accuracy.*

### Cuff Size Setup

Access the NIBP menu on the monitor and select "Setup". Then, you can select the appropriate cuff size.



### The NIBP cuffs for animals

Reusable	Disposable				
					
<p>ACC.NIBP Cuff Infant (9-14.8cm)</p>	<p>Disposable Suntech Vet NIBP Cuff #1 Range : 3 to 6 cm</p>	<p>Disposable Suntech Vet NIBP Cuff #2 Range : 4 to 8 cm</p>	<p>Disposable Suntech Vet NIBP Cuff #3 Range : 6 to 11 cm</p>	<p>Disposable Suntech Vet NIBP Cuff #4 Range : 7 to 13 cm</p>	<p>Disposable Suntech Vet NIBP Cuff #5 Range : 8 to 15 cm</p>

## 7. End-Tidal CO<sub>2</sub> (EtCO<sub>2</sub>)

This document will focus on the mainstream CAPNOSTAT<sup>®</sup> 5 sensor. If you purchased the sidestream LoFlo sensor, please contact technical support with any questions.

### 7.1. Turning the EtCO<sub>2</sub> Parameter On

Select the Menu on the right/bottom corner of the screen. Select Display Setup > Waveform Parameters. Turn on the EtCO<sub>2</sub> and click the X button to apply the changes and exit the menu.



### 7.2. Connecting the Sensor

Connect the EtCO<sub>2</sub> sensor to the CO<sub>2</sub> connector.

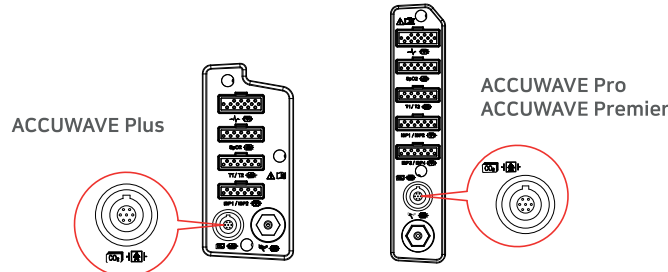

### 7.3. Sensor Warm-up

When you plug in your CAPNOSTAT<sup>®</sup> 5 or turn on your monitor with the CAPNOSTAT<sup>®</sup> 5 installed, it will go through a sensor warm-up process. You will see the message, "Wait For Sensor," and you must wait for this to complete (approximately 60 seconds) before you proceed with any EtCO<sub>2</sub> operations. The message will change to "Check Adapter" when the warm-up process is done.



### 7.4. Airway Adapter

Insert an airway adapter in the CAPNOSTAT<sup>®</sup> 5 sensor, then the message, "Check Adapter" will disappear. There are 2 airway adapters that come with the CAPNOSTAT<sup>®</sup> 5. One is for small animals and fit endotracheal tubes of 4mm and smaller, while the other is for large animals and fit endotracheal tubes that are larger than 4mm.

### The airway adapters for mainstream intubated applications

	Model	Picture	Description	
Disposable	6063-00		Large animals (Cat/Dog/Horse)	Adult/Pediatric 1 piece 5 cc Deadspace ET Tubes > 4.0 mm / Weight: 7.7 grams
	6312-00		Small animals (Others)	Neonatal/Pediatric 1 piece < 1 cc Deadspace ET Tubes <= 4.0 mm / Weight: 9.1 grams



There is an arrow on the airway adapter and a matching arrow on the CAPNOSTAT® 5. These need to be pointing toward each other when you install the airway adapter.



The image below on the left shows the CAPNOSTAT® 5 CO2 Sensor connected to a Respironics Novamatrix CO2 adapter. The image below on the right shows the CAPNOSTAT® 5 CO2 Sensor with an animal circuit.

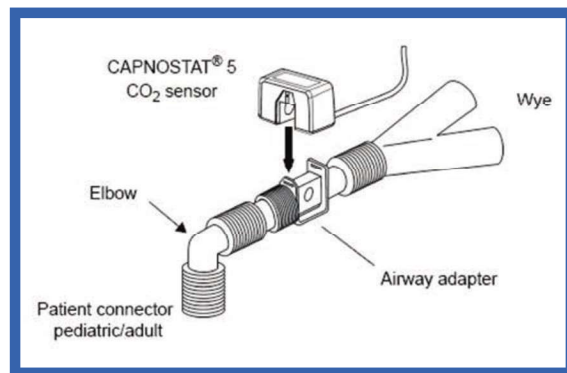
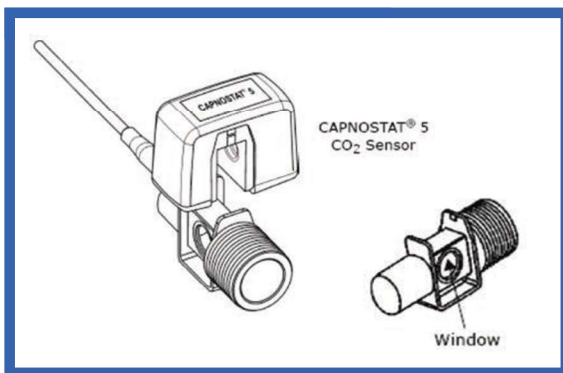

**Connect:** Slides on. Clicks into place.

**Remove:** Slides off.

### 7.5. Zeroing

Each time you install an airway adapter (before you connect the CAPNOSTAT® 5 to your patient and anesthetic machine), you need to zero it. This calibrates the sensor for the air in the room air and for the installed airway adapter. With an airway adapter installed, select the EtCO2 window, then choose the Module Setup tab, and press the Zero button. You will see a "Zeroing" message appear above the EtCO2 wave area that will last for 15 seconds. Once this message clears, you are ready to connect to your patient.

1. Zeroing should be Performed prior to every patient.
2. Wait for the sensor warm-up to complete before starting the zeroing process.
3. Use a fresh, clean, and dry airway adapter for each patient.
4. Ensure that the arrow on the adapter and the arrow on the sensor are pointing at each other.
5. The airway adapter should not be connected to the patient or the anesthetic machine. It should be open to room air on both sides.
6. Place the sensor on a stable surface and out of any air movement before it is zeroed.
7. Access the EtCO2 menu on the monitor and select "Zero".
8. Upon pressing "Zero" the windows will close automatically, and you'll observe a "Zeroing" message in the top right corner of the EtCO2 waveform.
9. Zeroing is complete.

**NOTE: Airway adapter must be installed before zeroing.**

**NOTE: For best result, connect the CAPNOSTAT® 5 CO2 Sensor to an adapter and wait 2 minutes before performing the Adapter Zero procedure.**

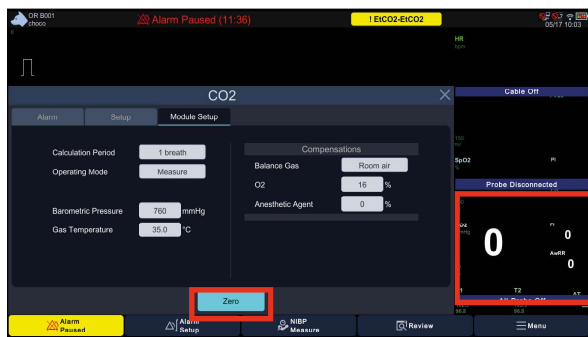

### 7.6. EtCO2 Display

- ① End-tidal CO2 value (EtCO2)
- ② Fraction of inspired CO2 (FiCO2)
- ③ EtCO2 alarm high/low limit value
- ④ Airway respiration rate



## 8. Dual Gas Module

Dual Gas sidestream module is intended for monitoring intubated and ventilated or non-ventilated small and large patients under anesthesia. The Dual Gas module is a multi-gas analyzer measuring carbon dioxide (CO2) and one of three anesthetic agents (Isoflurane, Sevoflurane, Desflurane) with manual selection of the specific agent type.

### 8.1. Installing the Water Trap Tank

Install the Water Trap Tank fitting from the top, and push and press the bottom until you hear a clicking sound.



### 8.2. Connecting the Sample Line and Airway Adapter

Plug in and twist to connect the line and adapter.

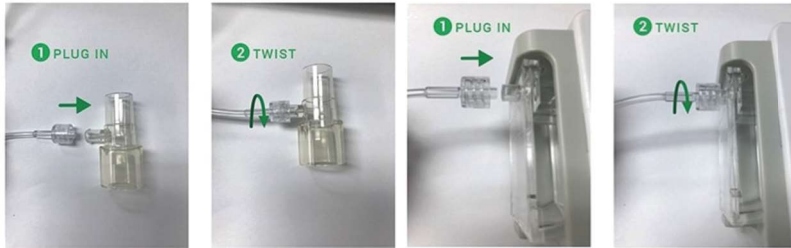

### 8.3. Mounting and Connecting the Sensor

Slide the Dual Gas Sensor module onto the bracket on the rear side of the ACCUWAVE monitors. And connect the sensor cable to the CO2 connector.

### 8.4. Turning the Dual Gas Parameter On

Select the **Menu** on the right/bottom corner of the screen. Select **Display Setup > Waveform Parameters**. Turn on the Gas and press the "X (close button)" to apply the changes and exit the menu.

**NOTE: EtCO2 will automatically turn off when Gas is selected.**



### 8.5. Dual Gas Display

- ① EtCO2 alarm upper/lower limit display
- ② EtCO2 concentration value
- ③ Inspiratory CO2 concentration value
- ④ Airway breathing rate per minute
- ⑤ Set anesthetic gas type and unit, End-stage (Et) alarm upper/lower limit value
- ⑥ Et value of set anesthetic gas
- ⑦ MAC value
- ⑧ Expiration (Fi) value of the set anesthetic gas

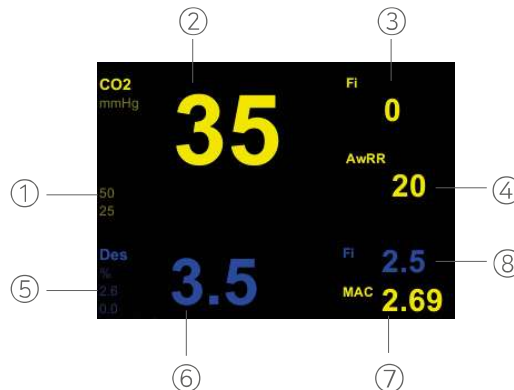

## 9. BT-Link Next

### 9.1. BT-Link Next

An automated veterinary monitor software program that allows you to interface Patterson veterinary monitors directly with a Windows-based computer.

**NOTE: The program installation file can be downloaded from the website [www.BionetUS.com](http://www.BionetUS.com)**  
**Link address: [www.BionetUS.com/btlinknext](http://www.BionetUS.com/btlinknext)**

### 9.2. BT-Link Next Mobile

A smartphone application that enables you to monitor one of the multiple Patterson veterinary monitors connected directly to a smartphone or tablet PC.

**NOTE: You can download the BT-Link Next Mobile App from the iOS App Store or Google Play Store.**

\*Please note that all pictures, images, and illustrations shown in this Quick Guide are for reference purposes only.

\*All other trademarks are property of their respective owners.

